

ANFIS-Based Effective Length of Vertical Rod Buried in Two-Layer Soil Subjected to Lightning Return Strokes

Ali Bagheri¹, Sajad Mehrabi², and Saeed Reza Ostadzadeh^{3*}

^{1,2} MSC students from Department of Engineering, Arak University, Arak, Iran.

³ Department of Engineering, Arak University, Arak, Iran.

ABSTRACT. In this paper, an adaptive network fuzzy inference system (ANFIS) based on the Takagi-Sugeno- Kang technique is used for predicting effective length of vertical rod buried in two-layer soils. The rod is subjected to two typical lightning return stroke currents namely first and subsequent stroke currents. To train the ANFIS approach, a number of input-output pairs are computed from the multi-conductor transmission line method. The inputs are resistivity values of the upper and lower layers, upper layer thickness and rise time of the lightning current. After the training process is converged, prediction of effective length is efficiently carried out in such soils. Also, comparative study with the horizontal electrode buried in two-layer soils shows that the effective length of vertical rod is considerably less than that of horizontal electrode which is financially and practically of importance, whereas in single-layer soil they are different.

KEYWORDS: Effective length, ANFIS, vertical rod, lightning stroke, two-layer soil.

1 INTRODUCTION

Tower-footing grounding systems such as vertical rod and horizontal electrode are used to discharge lightning current into the soil. To this aim efficiently, such a device is designed at effective length. It is conventionally defined as a starting length at which the slope of impulse impedance (ratio of maxima of transient voltage and injected current) versus the rod length is nil [1]. This definition leads to minimize the construction cost. Introducing closed-form expression for the effective length is practically of importance. This parameter is strictly dependent on the complex nature of the lossy soil including dispersion [2, 3], ionization [4], and non-homogeneity [5] separately and simultaneously [6-8]. Hence, researchers proposed formulae based on the curve-fit techniques for single-layer, and dispersive and ionized soils.

The only research on the two-layer soils is related to the harmonic impedance [9, 10], transient voltage [11]. Fig. 1 shows two conventional grounding systems namely horizontal electrode and vertical rod buried in two-layer soil. In this figure, ρ_1 , ρ_2 and h are respectively the upper and lower layer resistivity values, and upper layer thickness. These parameters affect the lightning performance of such devices. Recently, Kherif et al [5] have proposed closed-form expression for the effective length of horizontal electrode buried in two-layer soil based on combining numerical solution of the transmission line method (TLM) and genetic algorithm. To the best of our knowledge, there is no closed-form expression for the effective length of vertical rod buried in two-layer soils. This motivates the authors to propose efficient formulae for the effective length of vertical rod in such soils based on the adaptive network fuzzy inference system [12]. As reported in the literatures, ANFIS is very efficient in comparison with the other intelligent methods such as conventional fuzzy inference systems (FIS) [13-15]. During the last ten years, ANFIS has been found applications in electromagnetics for instance resonance frequency and radiation resistance of various microstrip antennas [16-19]. Further information about ANFIS in detail is given in the next section.

To create the ANFIS approach, a number of input-output pairs are needed in which the inputs are resistivity of upper and lower layers, upper layer thickness, and rise time of the injected current to rod/electrode while the effective length is the output. In this paper, they are computed from multi-conductor transmission line method (MTL) [20]. Validity of the MTL for computing effective length of grounding electrodes has been recently investigated in [21]. Although this modelling approach is efficient, to compute effective length it should be solved iteratively for different values of the rod length up to a starting length at which the slope of impulse impedance versus the rod length is nil.

Also, to include the rise time effect on the effective length, two ANFIS models are proposed separately under two typical lightning currents namely first and subsequent stroke currents. These two lightning currents have low and high rise time values which are conventionally used in analysing grounding systems under lightning strokes.

The simulation results show that the predicted results based on the ANFIS are in excellent agreement with the MTL. The proposed expression makes design of vertical rod very applicable and avoid the repetitive computations when the weather conditions are changed. Also as known in single-layer soil [22], the effective lengths of vertical rod and horizontal electrode are the same, whereas, they are different in two-layer soils which should be considered by power engineers. The difference between the effective lengths is more pronounced for first stroke current so that it is less than 70% for low-valued thickness. One of interesting notes is that the proposed expression can be used for both single and two-layer soils since when the resistivity values of upper and lower layers are identical, the two-layer soil is converted to single-layer soil. Besides, when the upper layer thickness is increased the behaviour of single and two-layer soils would be also the same.

This paper is organized as follows. In section 2, modelling principles of the MTL and ANFIS approaches are briefly introduced. Section 3 is focused on the simulation results based on the ANFIS and comparison with the MTL and the individual ones in horizontal electrode. Finally in section 4 concluding remarks are presented.

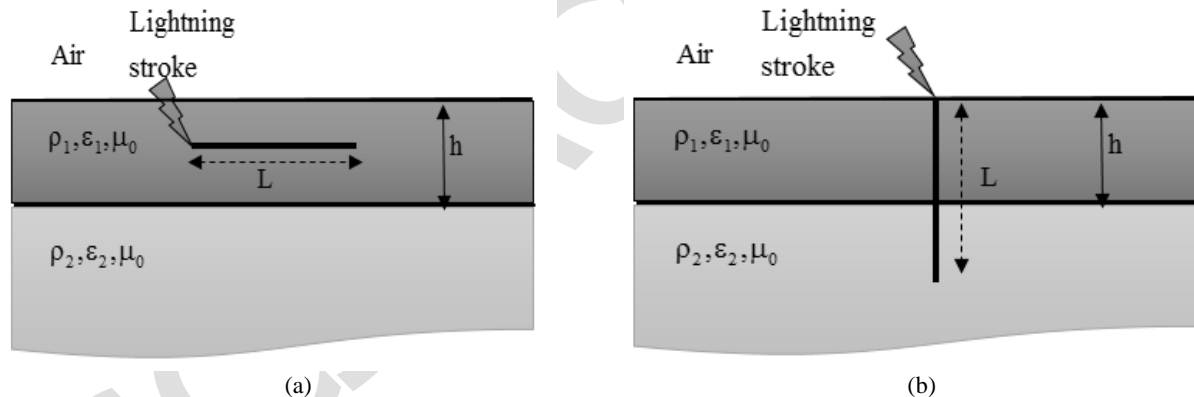

Figure 1: Two typical grounding systems buried in two-layer soil, (a): horizontal electrode, and (b): vertical rod.

2 MODELING PRINCIPLES

In this section, modelling principles of MTL and ANFIS respectively as exact and approximate approaches are briefly explained. In both models, it is assumed that two typical lightning currents namely first and subsequent stroke currents as shown in figure 2 are injected to the vertical rod. Mathematical formula for the two lightning currents is expressed in (1) and (2) using Heidler's functions, and its parameters are listed in Table 1. Note that the sum of two Heidler's functions is used to represent the subsequent return stroke current. This kind of lightning current is conventionally used for evaluating lightning performance of grounding systems [23, 24].

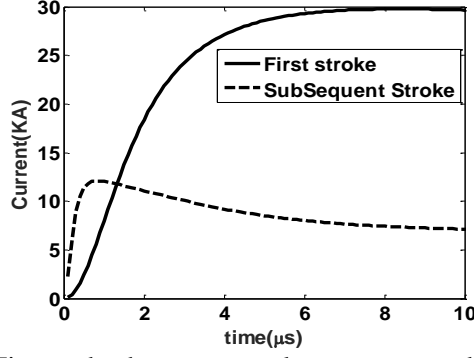

Figure 2. First and subsequent stroke currents used in this paper.

$$i(t) = (I_0 / \eta) \exp(-t / \tau_2) (t / \tau_1)^n / [1 + (t / \tau_1)^n] \quad (1)$$

where

$$\eta = \exp[-(\tau_1 / \tau_2) (n \tau_2 / \tau_1)^{1/n}] \quad (2)$$

Table 1. Parameters of lightning current adopted from [24].

Current	I_0 (kA)	n	τ_1 (μ s)	τ_2 (μ s)
First stroke	28	2	1.8	95
Subsequent stroke	10.7	2	0.25	2.5
	6.5	2	2	230

2. 1 MTL Approach

According to the MTL modelling approach [20], it is naturally a frequency domain method in which each set of parallel conductors is considered as multi-conductor transmission line (MTL) and connected to each other depending upon construction of the grounding systems. In the especial case for vertical rod, the rod of length L is divided into N segments of length $L_k = L/N$, $k=1,2,\dots,N$. The segment length L_k should be satisfied in the relation $L_k < \lambda/10$, where λ is wavelength. The very short segment improves the accuracy, but the run time increases. Here, we choose $L_k=0.5$ m resulting in satisfied results. Each segment is then called MTL. The sending and receiving voltages and currents for each segment are connected to each other through ABCD matrix as below

$$\begin{bmatrix} I_{sk} \\ I_{rk} \end{bmatrix} = \begin{bmatrix} A_k & B_k \\ C_k & D_k \end{bmatrix} \begin{bmatrix} V_{sk} \\ V_{rk} \end{bmatrix} \quad (3)$$

Where $A_k = D_k = Y_0 \coth(\Psi L_k)$ and $B_k = C_k = -Y_0 \operatorname{csch}(\Psi L_k)$. Y_0 and Ψ are respectively characteristic admittance and propagation constant in the transmission line equations. Then as shown in Fig. 3, the rod is illustrated as N cascaded MTLs. All MTLs are connected to each other via Kirchhoff's voltage law (KVL) and Kirchhoff's current law (KCL). For instance, the voltages and currents at connection point of two segments are the same. At the beginning of first segment, the current (I_s) is the same as the lightning current, whereas at the end of last segment the current is nil. The goal is that to compute the sending voltage at the injection point in time domain. Hence, spectral content of the two lightning currents should be first extracted at M frequencies f_i , $i=1,2,\dots,M$, and the MTL equations should be solved at each frequency separately. Applying inverse fast fourier transform (IFFT) to the ending voltage, results in computing it in time domain (transient voltage) and its maximum is then computed (V_{max}). Finally, the impulse impedance $Z_p = V_{max} / I_{max}$ is easily computed where I_{max} is maximum value of the lightning current. The mentioned process is iteratively carried out with the length decrement ΔL up to a length at which the slope of impulse impedance versus the rod length is nil, i.e., effective length (L_{eff}). Fig. 4, shows the iteration process of the MTL algorithm for computing transient voltage and accordingly effective length.

For the problem under consideration, at first the spectral contents related to two lightning currents, i.e., first and subsequent stroke currents, are extracted in the time interval of $[0, 10]\mu\text{s}$ and tabulated in Table 2. Then, equivalent electrical parameters of two-layer soil [25] are computed at each frequency inside the spectral contents as below

$$\rho_{\text{eq}} = \rho_1 \left[\frac{(\sqrt{\rho_2} + \sqrt{\rho_1}) + (\sqrt{\rho_2} - \sqrt{\rho_1})e^{-2h\sqrt{\pi f \mu_0 / \rho_1}}}{(\sqrt{\rho_1} + \sqrt{\rho_2}) - (\sqrt{\rho_2} - \sqrt{\rho_1})e^{-2h\sqrt{\pi f \mu_0 / \rho_1}}} \right]^2 \quad (4)$$

All parameters except frequency (f) in (4), are illustrated in Fig. 1. Frequency (f) is adopted from Table .2. After then the MTL approach is applied to each frequency. The mentioned process is repeated for each increased length with decrement $\Delta L=0.5\text{m}$. Once the impulse impedance versus the rod length is converged, the starting length in the convergence process is extracted as effective length.

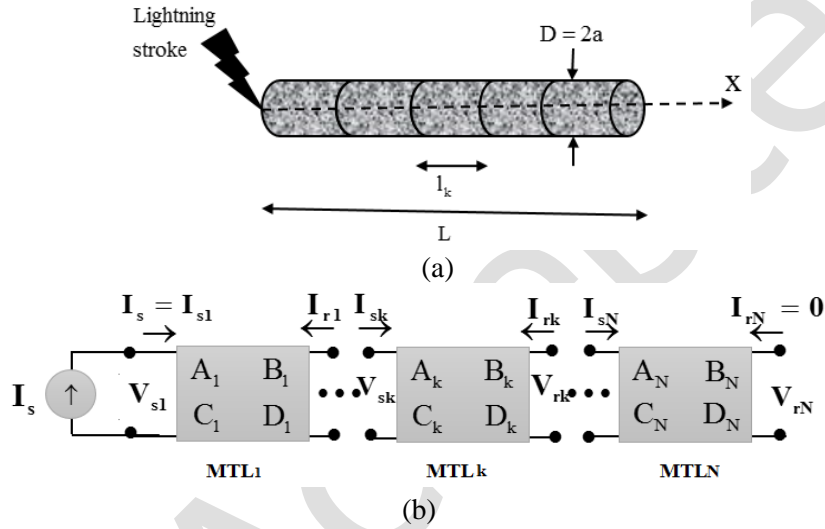

Figure 3: Illustrating the vertical rod as N segments and cascade of MTLs in the frequency domain.

Table 2. Spectral content of the first and subsequent stroke currents in this paper.

Current	First stroke			Subsequent stroke		
Frequency(Hz)	245.7	1018.7	510.7	409	10477	6213
$I_s(\text{kA})$	551×10^2 $\angle 30^{\text{deg}}$	760×10^2 $\angle 87^{\text{deg}}$	391×10^2 $\angle -20^{\text{deg}}$	8.54 $\angle 39^{\text{deg}}$	13.62 $\angle 75^{\text{deg}}$	72.11 $\angle -65^{\text{deg}}$

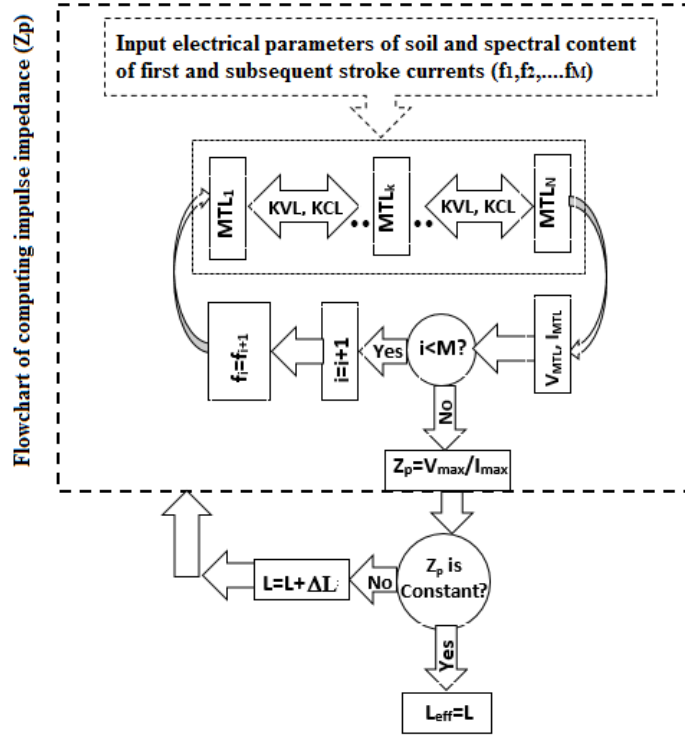

Figure: 4. Iteration process in the MTL for computing effective length of the rod.

2.2 ANFIS Approach

ANFIS is a class of adaptive networks that are functionally equivalent to fuzzy inference systems [13-15]. The ANFIS architecture consists of five layers including fuzzy layer, product layer, normalized layer, defuzzy layer, and summation layer. A typical architecture of ANFIS for the problem under consideration consisting three inputs, and single output is depicted in Fig. 5, in which a circle indicates a fixed node, whereas a square indicates an adaptive node. As seen in Fig. 5 for the problem under consideration, the output of ANFIS is effective length (L_{eff}), while the inputs are the resistivity of upper and lower layers (ρ_1, ρ_2), and upper layer thickness (h).

In the first layer, the inputs with the use of fuzzy sets are converted to fuzzy inputs with fuzzy values like small, medium and high. In Fig. 5, fuzzy sets of $A_i, B_i, C_i, i=1,2,..N$, are used for three inputs. The fuzzy sets have belongingness value between 0 and 1 and expressed with Gaussian functions as below

$$\mu(x) = \exp\left[-\left(\frac{x - c_i}{\sigma_i}\right)^2\right], i = 1, 2, \dots, N \quad (5)$$

where c_i, σ_i are respectively center and deviation of the fuzzy sets which are adjusted in the training process using input-output pairs and x is input variable. For the problem under consideration, each input is expressed with three fuzzy sets.

In the second layer, a weighting factor for each rule is defined as $w_i = \mu_{A_i}(\rho_1)\mu_{B_i}(\rho_2)\mu_{C_i}(H)$, $i = 1, 2, 3$ where μ_A, μ_B and μ_C are belongingness of the fuzzy sets for inputs.

In the third layer, a normalized weighting factor as defined in (6) is used.

$$\bar{w}_i = \frac{w_i}{\sum_{i=1}^{27} w_i}, i = 1, 2, \dots, 27 \quad (6)$$

In the fourth layer, the output of FIS is expressed as If-Then rules as follows

$$\text{if } (\rho_1 \text{ is } A_j), (\rho_2 \text{ is } B_j), \text{ and } (H \text{ is } C_j) \text{ then } z_i = p_i\rho_1 + q_i\rho_2 + k_iH + r_i \quad i = 1, 2, \dots, 27, j = 1, 2, 3 \quad (7)$$

For the problem under consideration, 27 if-then rules as expressed above is used.

In the last layer, the output is finally computed as below

$$L_{\text{eff}}(\rho_1, \rho_2, H) = \sum_{i=1}^{27} \bar{w}_i (p_i \rho_1 + q_i \rho_2 + k_i h + r_i) \quad (8)$$

In (8), the coefficients p_i, q_i, k_i are computed in the training process based on the least square error technique.

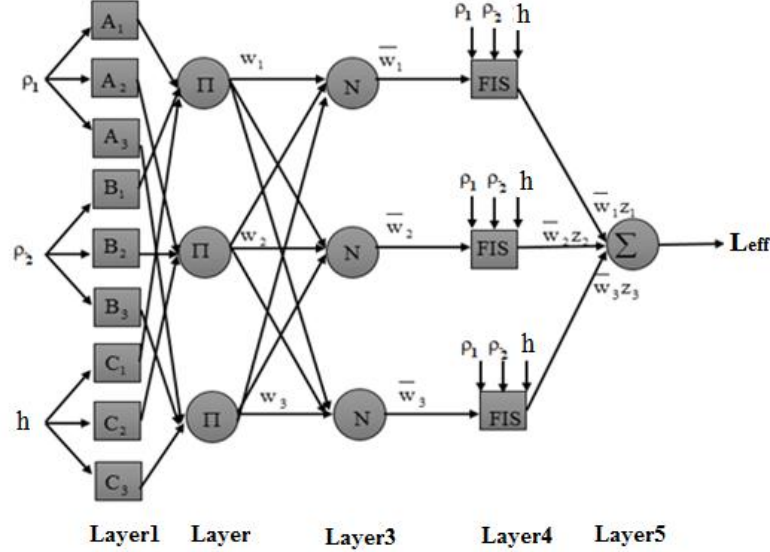

Figure: 5. Schematic of ANFIS approach for the problem under consideration.

3 COMPARATIVE STUDIES

In this section the proposed models under the first and subsequent stroke currents are evaluated and validated with the MTL. Then they are compared with the individual ones in horizontal electrode [5].

3.1 Comparison with MTL

To create the ANFIS model in this study, $3 \times 3 \times 3 = 27$ input-output pairs are computed using MTL approach and used in the training process, and each input is expressed linguistically by three fuzzy sets like *small*, *medium*, and *high*. The samples for upper and lower layer resistivity and thickness are respectively selected in the intervals of $[100, 1000] \Omega\text{m}$, $[100, 1000] \Omega\text{m}$, and $[1, 10] \text{m}$. Note that for computing effective length, a length decrement $\Delta L = 1 \text{m}$ has been used. Once the training process is converged, the model can be used for predicting the effective length. Fig. 6 shows the root mean square error (RMSE) versus epoch in the training process for the two mentioned currents. From this figure, after 20 epochs the two models are converged.

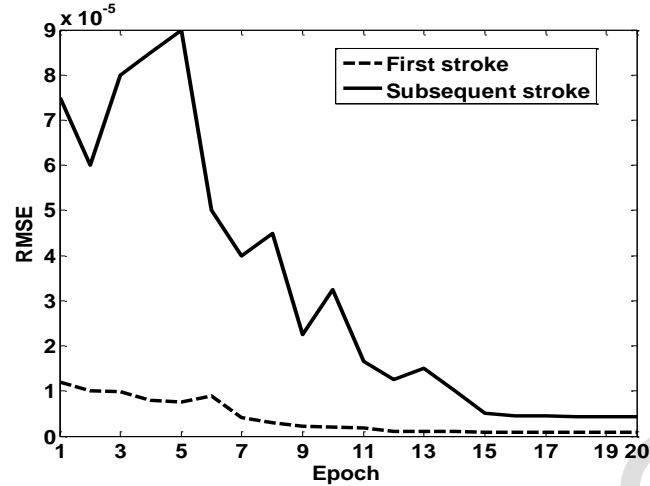

Figure 6: Root mean square error (RMSE) versus epoch for the first and subsequent stroke currents.

To validate the created models, they are investigated for different scenarios as shown in Figs. 7 and 8 respectively for the first and subsequent stroke currents. In the vertical axis of these figures, superscripts ‘1ST’ and ‘SUB’ are denoted for the first and subsequent stroke currents respectively. As can be seen in these figures, excellent agreement in comparison with the MTL approach is achieved. In addition, comparison of Figs. 7 and 8 shows that the same as single-layer soil, effective length for subsequent stroke current is less than that of first stroke current. It is physically because of higher frequency content of subsequent current and accordingly more attenuation of induced electric field inside the soil. Figs 7, 8 (c) show that when the upper layer thickness is increased, the effective length is converged to a constant value which is effective length in single-layer soil. Finally, the approximate run-times of different existing methods for computing effective length are compared in Table 3. From this table, ANFIS has the lowest run-time with respect to the other methods which is of importance in engineering point of view. Note that the run-time of ANFIS is valid after the training process is converged.

Table 3: Comparison of approximate run-time of different methods.

Current	ANFIS	MTL [5]	TLM [22]
First stroke	0.5sec	15sec	30sec
Subsequent stroke	0.5sec	25sec	48sec

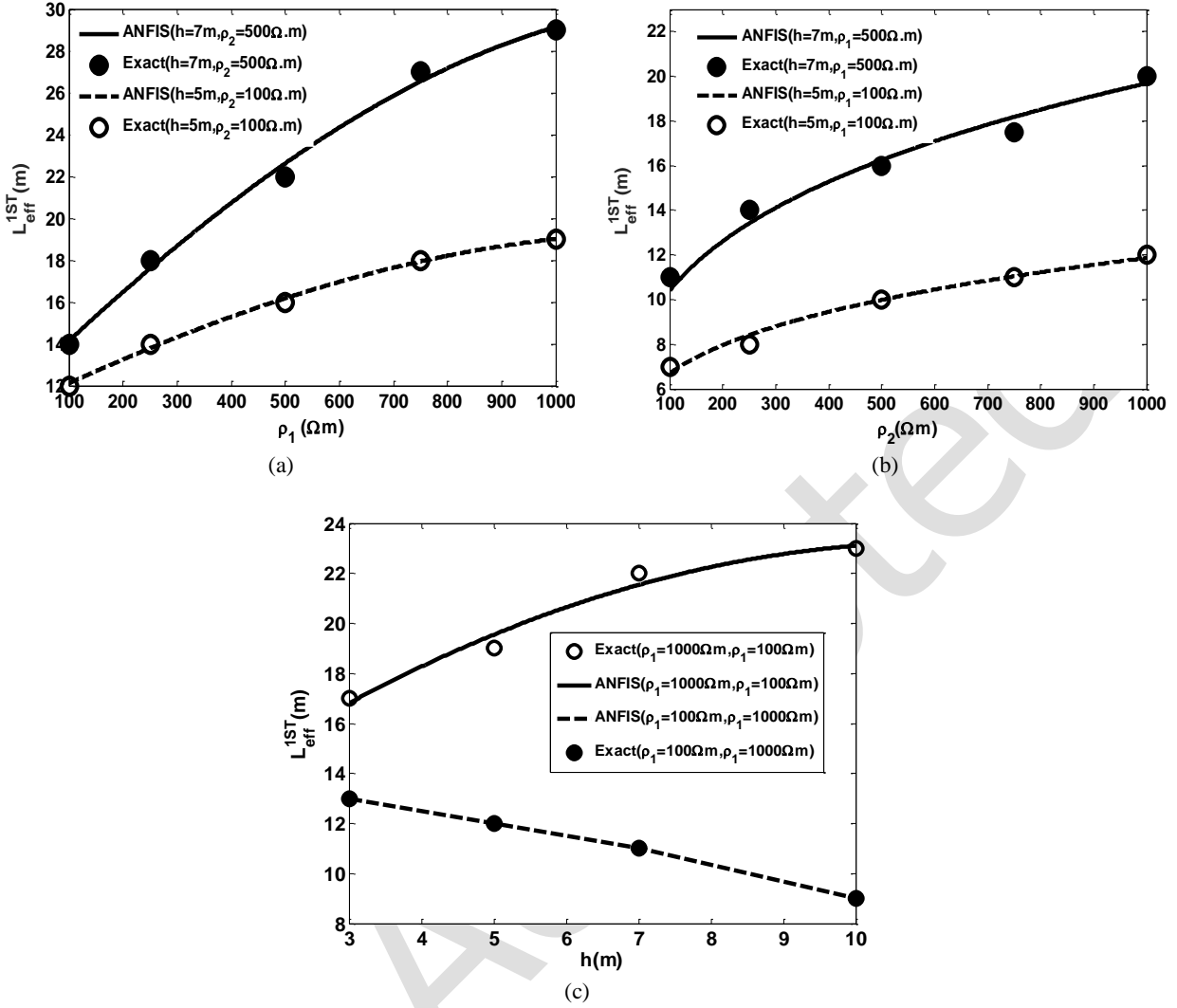
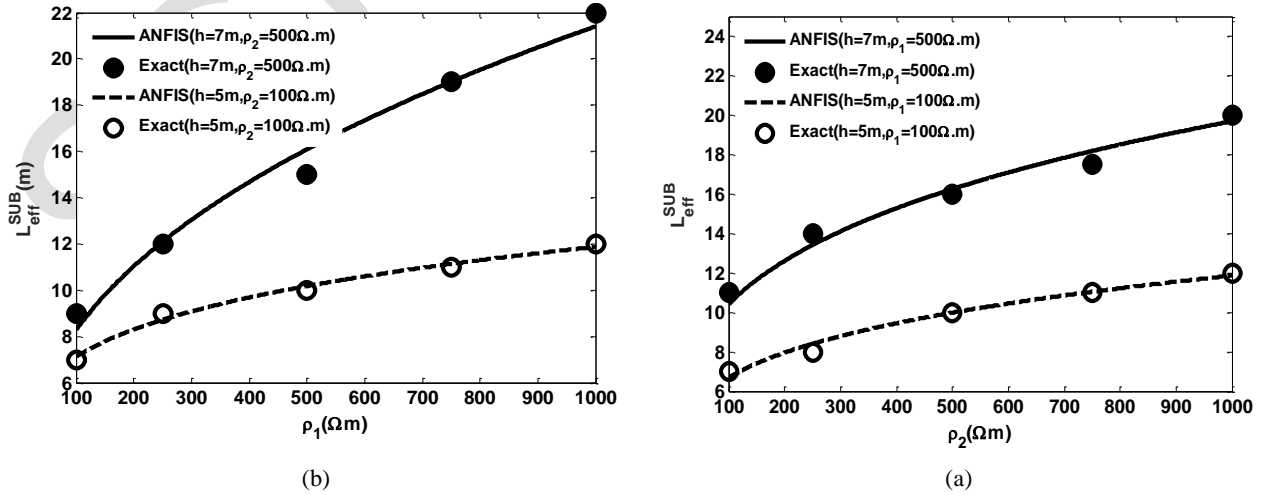

Figure 7: Effective length of vertical rod under first stroke current versus (a): upper layer resistivity (b): lower layer resistivity, and (c) upper layer thickness.



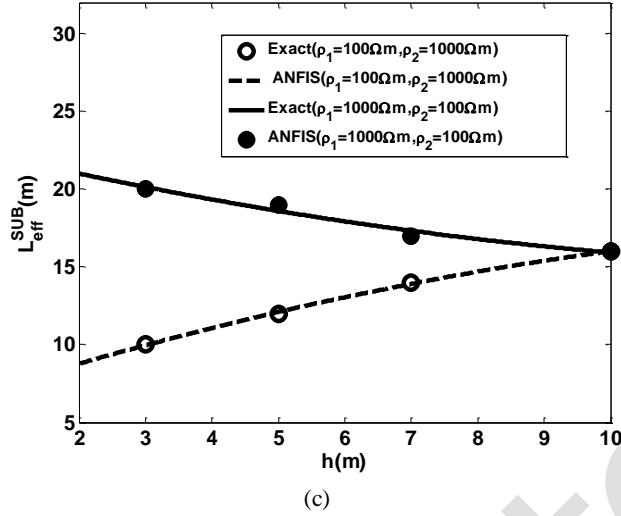

Figure 8: Effective length of vertical rod under subsequent stroke current versus (a): upper layer resistivity (b): lower layer resistivity, and (c) upper layer thickness.

3.2. Comparison with Horizontal Electrode

As proven in [23], the effective lengths of vertical rod and horizontal electrode buried in single-layer soils are identical. Now this issue is investigated in two-layer soils. To this end, the proposed expression in this study is compared with the individual one of horizontal electrode [5]. The comparison results for both currents are shown in Fig. 9. In this figure, the upper and lower layer resistivity values are respectively 100 Ω m, and 1000 Ω m, and the upper layer thickness is varied in the interval of [1, 10]m. From this figure, one can see that the effective length of horizontal electrode is greater than that of the vertical rod. This difference is more pronounced for the first stroke current so that when the upper layer thickness is 1m, the maximum difference is 69% and 33% respectively for the first and subsequent stroke currents. On the other hand, when the upper layer thickness is increased, the difference between the effective lengths is decreased. This is because of converting the two-layer soil into single-layer soil. This conversion is faster carried out for the subsequent stroke current. In addition, in the case of subsequent stroke current when the upper layer thickness is equal to 6m, both effective lengths are identical. The mentioned finding makes application of vertical rod more suitable financially in two-layer soils in comparison with the horizontal electrode which should be noticed by power engineers.

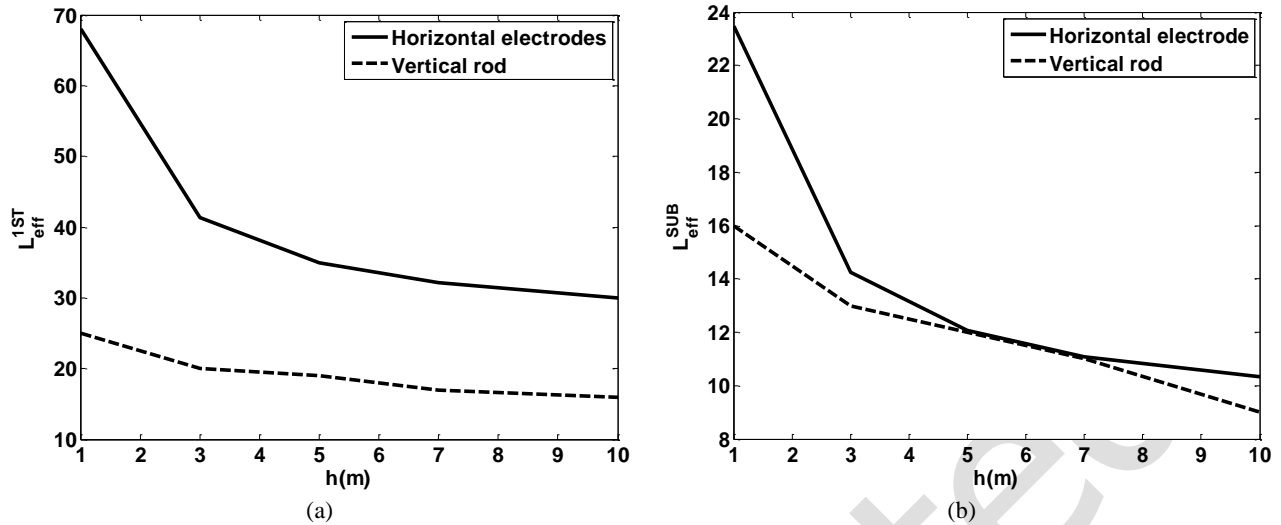

Figure 9: Comparison of effective lengths of vertical rod and horizontal electrode versus upper layer thickness under (a): first and (b): subsequent stroke currents.

4 CONCLUSION

In this paper, closed-form expression for effective length of vertical rod under lightning strokes and buried in two-layer soils is extracted. It is based on the adaptive network fuzzy inference system (ANFIS). In extracting the expression, a few input-output pairs are needed which are computed from the multi-conductor transmission line method. Based upon the research in this study, the following findings are extracted:

1-The proposed expression is very efficient. This makes it suitable from practical point of view especially when the climate conditions are changed.

2- Due to the proposed expression, predicting the effective length of vertical rod in single and two-layer soils can be simultaneously carried out. Note that when the resistivity values of upper and lower layers in two-layer soil are the same, the two-layer soil is converted to the single-layer soil.

3-Effective lengths of vertical rod and horizontal electrode buried in two-layer soils are different, whereas in single-layer soils they are the same.

The above notes should be considered by power engineers. The proposed approach can be similarly applied for the grounding grid under lightning strikes that is in progress.

REFERENCES

- [1] Liu Y. "Investigating the validity of existing definitions and empirical equations of effective length/area of grounding wire/grid for transient studies", *J. Electrostat.* vol. 65, no. 4, pp. 329-335, 2007. <https://doi.org/10.1016/j.elstat.2006.09.005>.
- [2] Alipio R, Visacro S. "Impulse efficiency of grounding electrodes: effect of frequency-dependent soil parameters", *IEEE Trans Power Del.* Vol. 29, no. 2, pp. 716-723, 2014. <https://doi.org/10.1016/j.epsr.2019.105927>
- [3] Rafael Alipio, and Silverio Visacro, "Impulse Efficiency of Grounding Grids: Effect of Frequency-dependence Soil Parameters", *IEEE Transaction on Power Delivery*, vol. 29, no. 2, pp. 102-108, August 2015. <https://doi.org/10.1016/j.epsr.2012.04.011>
- [4] He J, Gao Y, Zeng R, et al. "Effective length of counterpoise wire under lightning current", *IEEE Trans Power Del.* Vol. 20, no. 2, pp. 1585-1591, 2005. <https://doi.org/10.1109/TPWRD.2004.838457>
- [5] O. Kherif, S. Chiheb, M. Teguar, A. Mekhalidi, and N. Harid, "Investigation of horizontal ground electrode's effective length under impulse current," *IEEE Trans. Electromagn. Compat.*, vol. 61, no. 5, pp. 1515-1523, Oct. 2019. <https://doi.org/10.1109/TEM.2018.2864130>
- [6] Senthil Kumar A and Krishnan Manickavasagam, "Transmission Line Dynamic Circuit Model for Effective Length of Ground Electrode Under Lightning Transients", *IEEE Transactions on Electromagnetic Compatibility*, vol. 64, no. 2, pp. 1-8, 2022. <https://doi.org/10.1109/TEM.2021.3124679>

- [7] Sajjadi Seyyed Sajjed, Aghajani Vahid and Ostadzadeh Saeed Reza, "Comprehensively Formulae for Effective Length of Multiple Rods Considering Different Aspects of Soil: Improved MTL-Intelligent Water Drop Algorithm", *International Journal of Numerical Modelling, Electronics, Network Devices, and Fields*, vol. 33, no. 4, pp. 1-20, 2020 <https://doi.org/10.1002/jnm.2721>
- [8] Sajjadi Seyyed Sajjed, and Ostadzadeh Saeed Reza, "Predicting formulae for effective length of counterpoise wires buried in ionized, dispersive and inhomogeneous soils", *COMPEL-The international journal for computation and mathematics in electrical and electronic engineering*, vol. 39, no. 6, pp. 1375-1391, 2020. <https://doi.org/10.1109/COMPEL-08-2019-0327>
- [9] Karami H, Sheshyekani K, Rachidi F. "Mixed-potential integral equation for full-wave modeling of grounding systems buried in a Lossy multilayer stratified ground", *IEEE Trans Electromagn Compat.* vol. 59, no. 5, pp.1505-15013, 2017. <https://doi.org/10.1109/TEMC.2017.2655497>
- [10] Karami H, Sheshyekani K., "Harmonic impedance of grounding electrodes buried in a horizontally stratified multilayer ground: a fullwave approach", *IEEE Trans Electromagn Compat.* Vol. 59, no. 5, pp. 1505-1513, 2017. <https://doi.org/10.1109/TEMC.2017.2759259>
- [11] Hossein Zamani, and Keyhan Sheshyekani, "Method of Line for Modeling of Grounding Electrodes Buried in Stratified Multilayer Soil", *IEEE Trans Electromagn Compat.* vol. 64, no. 6, pp. 1-10, 2022. <https://doi.org/10.1109/TEMC.2022.3210469>
- [12] Jyh-Shing Roger Jang, "ANFIS: Adaptive-Network-Based Fuzzy Inference System", *IEEE Transaction on Systems, Man, and Cybernetics*, vol. 23, no. 3, pp. 665-681, 1993. <https://doi.org/10.1109/21.256541>
- [13] عباسی، حایه، شمسی، محبوبه، رسولی کناری، عبدالرضا، «تشخیص عملکرد کاربران و ارائه روشی برای تعیین میزان خطر رفتار غیرمعمول کاربران در خانه هوشمند مبتنی بر منطق فازی، مجله محاسبات نرم، جلد ۲، شماره ۱، صفحه ۲-۱۳، ۱۳۹۹.
- [14] مرادی فراهانی، عسگری ج.، ذکری م. «مروری بر منطق فازی نوع-۲: از پیدایش تا کاربرد، مجله محاسبات نرم، جلد ۲، شماره ۱، صفحه ۲۲-۴۳، ۱۳۹۲.
- [15] آخوندی ر.، حسینی ر. «ارایه مدل هوشمند هایپریدی فازی تکامل ژنتیکی تفاضلی در یک سیستم خبره فازی- برای پیش بینی خطر ابتلا به بیماری قلبی مجله محاسبات نرم، مجله محاسبات نرم، جلد ۶، شماره ۲، صفحه ۳۲-۴۷، ۱۳۹۶.
- [16] Guney K., and Sarikaya N., "Adaptive neuro-fuzzy inference system for computing the resonant frequency of electrically thin and thick rectangular microstrip antennas", *International Journal of Electronics*, vol. 94, no. 9, pp. 833-844, September 2007. <https://doi.org/10.1080/00207210701526317>
- [17] Youssef harkouss, "Accurate modeling and optimization of microwave circuits and devices using adaptive neuro-fuzzy inference system", *International Journal of Microwave and Wireless Technologies*, vol. 3, no. 6, pp.637-645, 2011. <https://doi.org/10.1017/S1759078711000651>
- [18] Aghajani V., Sajjadi S. S., Ostadzadeh S. R., "Design of Grounding Vertical Rods Buried in Complex Soils Based on Adaptive Network-Based Fuzzy Inference systems", *Journal of Communication Engineering (JCE)*, vol. 7, no. 2, pp. 26-38, 2018. <https://doi.org/10.22070/jce.2018.3371.1090>
- [19] Guney K., "Comparison of Mamdani and Sugeno Fuzzy Inference System Models for Resonant Frequency Calculation of Rectangular Microstrip Antennas", *Progress In Electromagnetics Research B*, vol. 12, pp. 81-104, 2009. <https://doi.org/10.2528/PIERB08121302>
- [20] Jardines A, Guardado JL, Torres J, Chavez JJ, Hernandez M. "A multiconductor transmission line model for grounding grid", *Electr Power Energy Syst.* vol. 60, pp. 24-33, 2014. <https://doi.org/10.1016/j.ijepes.2014.02.022>
- [21] Ostadzadeh Saeed Reza, "Validity of Improved MTL for Effective Length of Counterpoise Wires under Low and High-Valued Lightning Currents", *AEM Journal*, vol. 9, no. 1, pp. 71-77, 2020. <https://doi.org/10.7716/aem.v9i1.1383>
- [22] Greve L., "Impulse efficiency of Ground Electrodes", *IEEE Transaction on Power Delivery*, vol. 24, no. 1, pp. 441-451, January 2009. <https://doi.org/10.1109/TPWRD.2008.923396>
- [23] Akbari M., Sheshyekani K., and Alemi M. R., "The effect of frequency dependence of soil electrical parameters on the lightning performance of grounding systems," *IEEE Trans. Electromagn. Compat.*, vol. 55, no. 4, pp. 739-746, Aug. 2013. <https://doi.org/10.1109/TEMC.2012.2222416>
- [24] Osama E. Gouda; Adel Zein El Dein Mohamed; Mosleh M. Al-Harathi; Sara Yassin Omar; "Performance of Grounding Electrodes Under Lightning Strokes in Uniform and Two-Layer Soils Considering Soil Ionization", *IEEE ACCESS*, vol. 10, no.2, pp. 1-15, 2022. <https://doi.org/10.1109/ACCESS.2022.3192394>
- [25] Tsiamitros D. A., Papagiannis G. K., and Dokopoulos P. S., "Homogenous Earth Approximation of Two-Layer Earth Structures: An Equivalent Resistivity Approach," *IEEE Trans. on Power Delivery*, vol. 22, no. 1, pp. 658-666, 2007. <https://doi.org/10.1109/TPWRD.2006.881465>